

■ CAMERA INSTALLATION

To check the complete user manual and free PC CMS software (CMS Lite), please scan the QR code or go to www.surveillance-download.com/user/m650.swf

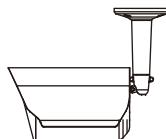

■ TYPE1



▼ Standard package

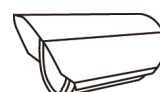

Camera



Instructions



Bracket



CD manual



3-pin terminal block



Screws & wall plugs

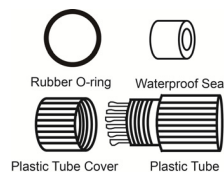

Waterproof kit

Step1: Fix the bracket to where you want to install the camera with the supplied screws.

Note: A file for its installation sticker could be downloaded from www.surveillance-download.com/user/a_installation_sticker.pdf.

Step2: Remove the Joint Lock from the bracket. Then, connect the Joint Lock to the backside of the camera.

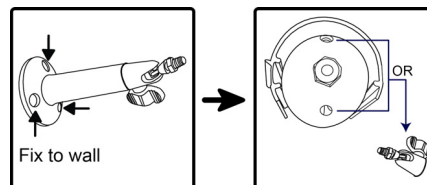

Step3: Connect the camera with the Joint Lock connected to the bracket, and secure the Joint Lock to fix.

Step4: (Optional) To install a microSD card if supported, open the camera front cover, and refer to the section of "INSERT A MICRO SD CARD" for details.

Step5: (Optional) To adjust the focus and focal length if supported, open the front cover of the camera, and refer to the section of "ADJUST FOCAL LENGTH & FOCUS" for details.

Step6: Power on the camera and adjust the viewing angle of the camera.

Note: Please adjust the angle up and down within 30 degree respectively, left and right within 15 degree respectively.

Step7: Fasten the sun shield to the camera with the supplied screw.

Note: Secure the Joint Lock tightly to avoid the camera dropping down.

■ TYPE2

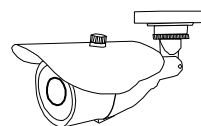

▼ Standard package

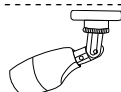

Camera



Sun Shield



Instructions



Screws & wall plugs



Screw for Sun Shield

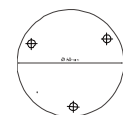

Installation Sticker



CD manual



Wrench

Step1: Find the supplied installation sticker, and paste it to where you want to install.

Then, screw holes as marked on the sticker for installation later.

Step2: Loosen the screw as indicated below to move down the camera lens.

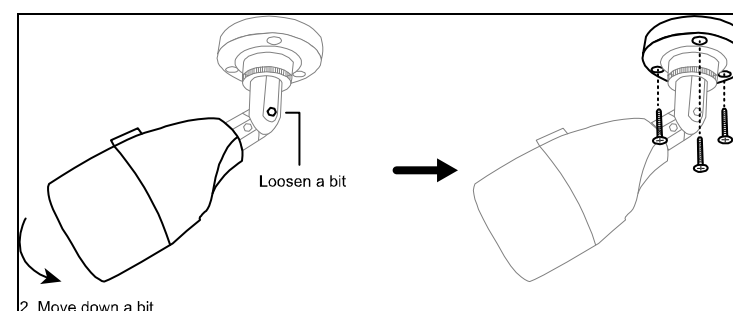

Step3: Adjust the viewing angle of the camera as indicated below.

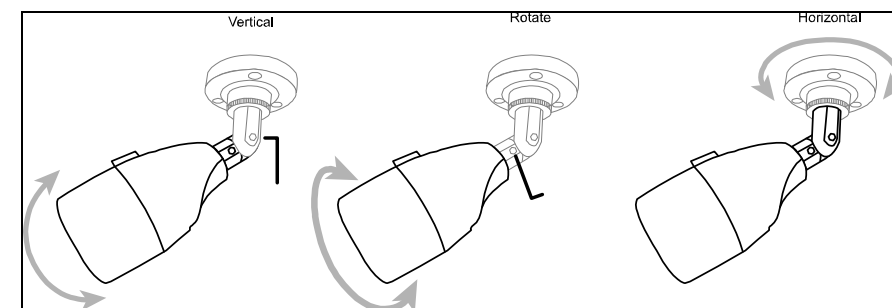

Step4: Slide the sun shield to the camera, and fasten it with the supplied screw.

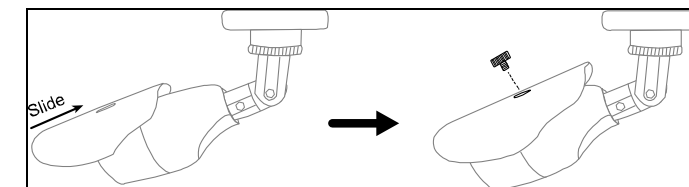

Step5: Power on the camera and fine-tune the viewing angle.

■ TYPE3

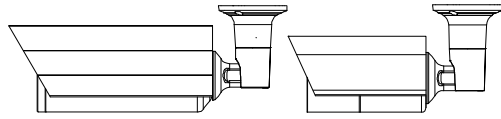

▼ Standard package

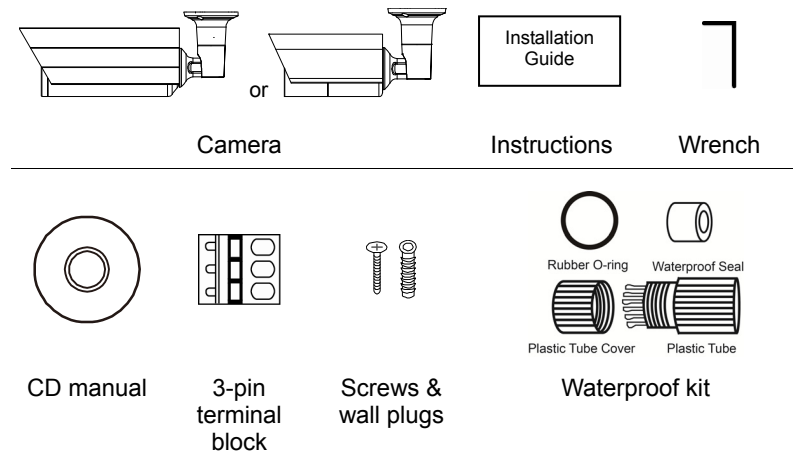

Step1: Remove the sun shield from the camera.

Step2: Locate where you want to install this camera, and fasten the camera to the ceiling or wall (*Figure 1*).

Note: A file for its installation sticker could be downloaded from www.surveillance-download.com/user/c_installation_sticker.pdf.

Note: It's recommended to slightly loosen the screw on the bracket as indicated below to move the camera down a little bit. It's easier for bracket installation.

Step3: Adjust the viewing angle of the camera, as indicated in *Figure 2*.

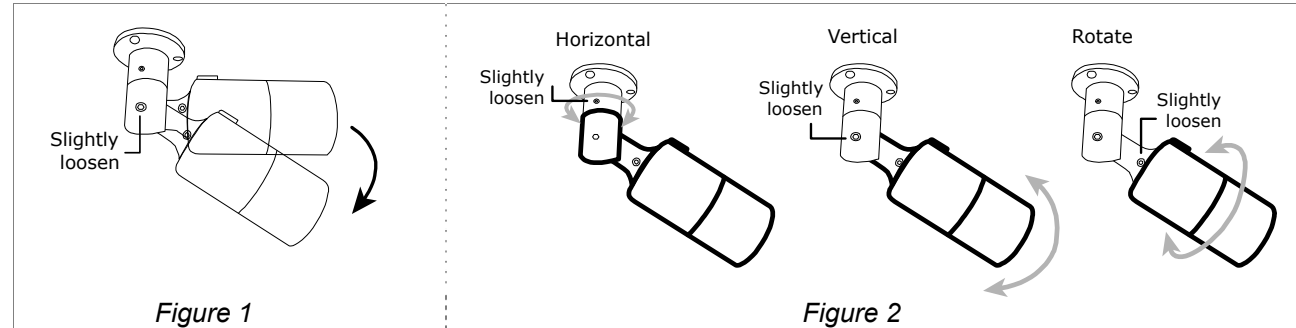

Step4: (Optional) To install a microSD card if supported, open the camera front cover, and refer to the section of "INSERT A MICRO SD CARD" for details.

Step5: (Optional) To adjust the focus and focal length if supported, open the front cover of the camera, and refer to the section of "ADJUST FOCAL LENGTH & FOCUS" for details.

Step6: Fasten the sun shield to the camera with the supplied screw.

Note: In order to make the best performance, please adjust the angle of IR shift up and down within 30 degree respectively, left and right within 15 degree respectively.

Note: If the temperature of the installation environment is under 0°C, 50 minutes or more will be needed for the camera to warm up.

■ TYPE4

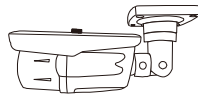

▼ Standard package

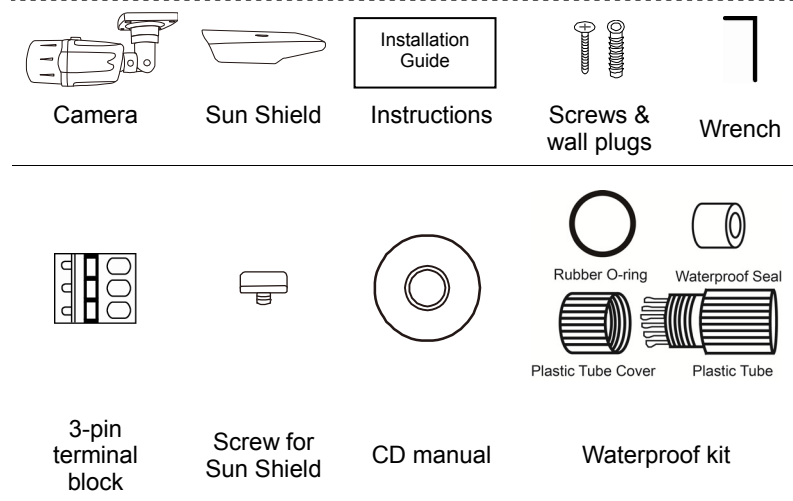

Step1: Loosen the screw as indicated below to move down the camera lens.

Then, locate where to install this camera, and fasten the camera to the ceiling or wall.

Note: An installation sticker is supplied within the sales package to help you drill screw holes on the ceiling or wall to secure the camera.

Step2: Adjust the viewing angle of the camera as indicated below.

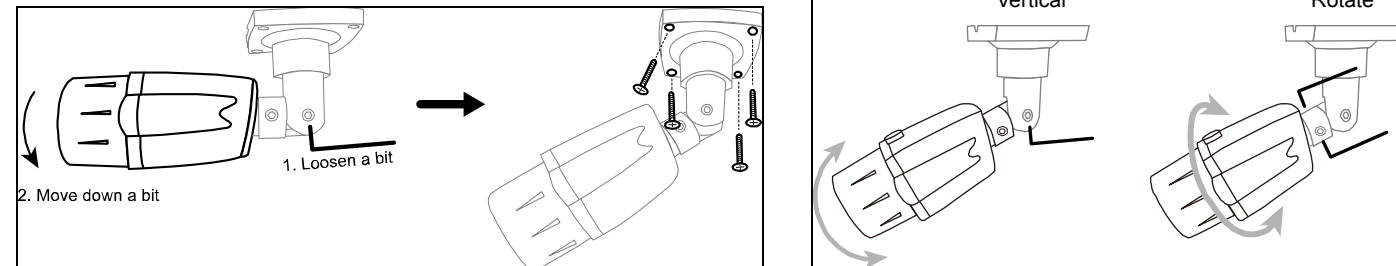

Step3: Slide the sun shield to the camera, and fasten it with the supplied screw.

Step4: Power on the camera.

(For vari-focal model) adjust the focal length and focus by turning the screws as indicated on the right.

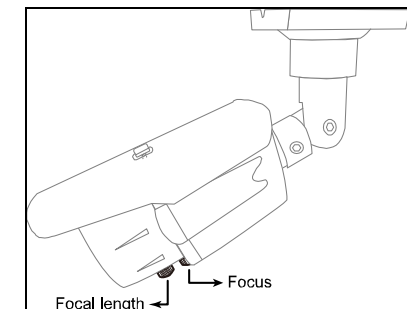

■ ADJUST FOCAL LENGTH & FOCUS

FOR TYPE 1 AND 3 SELECTED MODELS ONLY

Manually: For the vari-focal camera that its front cover could be removed.

Note: The appropriate temperature for focus adjustment is 0°C ~ 40°C, and prevent adjusting in moisture environment.

Step1: Make sure the camera power is on. Then, remove the front cover.

Step2: Find two handles on the camera as shown below. Move the handle near to the main board first to find the best surveillance area, and move the hand near to the lens to adjust the sharpness of the image.

Step3: Place the front cover back and fasten it tightly.

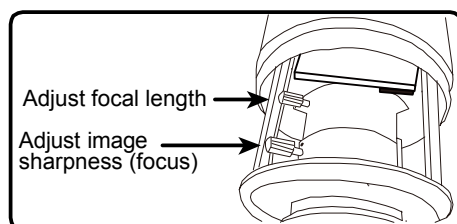

Remotely: For the vari-focal camera that its front cover could NOT be removed.

To remotely adjust focal length and focus of the camera, access the camera from Internet Explorer.

Note: The default camera IP address is 192.168.1.10, the port number is 88, and the user name and password are both admin.

To search the IP address and port number, you could download our IP scan tool from www.surveillance-download.com/user/m650.swf.

In the tab of "Live View", you'll see the icons in the control panel area as below:

	Zoom Tele / Zoom Wide	Click to zoom in on the image to the largest / zoom out on the image to its original size.
	Max Zoom Tilt / Max Zoom Wide	Click to zoom in / out the image.
	Focus Far / Near	Click to adjust the focus of the image.

Note: You can also adjust the focal length and the focus by accessing to the NVR with PTZ controlling. For more detail, please refer to the NVR manual.

■ WATERPROOF KIT

FOR SELECTED MODELS ONLY

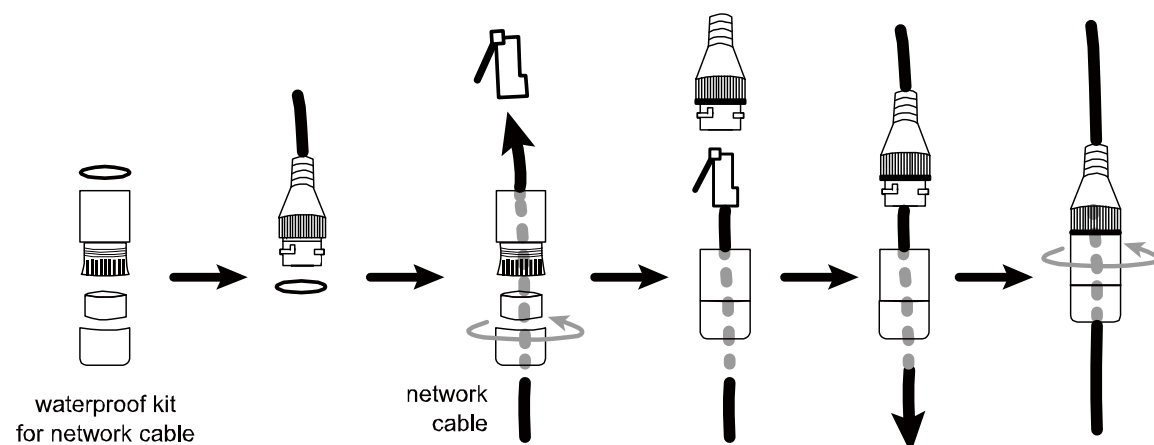

■ DEFAULT VALUES

IP address	192.168.1.10
Port number	88
User name	admin
Password	admin

It's strongly recommended to change the default user name and password before using the camera to keep your account safe.

To change the default account, log into the camera, and go to **Config.** → **General** → **Account**. Create a new account, and remove the default one.

■ CABLE

Cable	Description
Power cable	DC12V power supply.
RJ45 network cable*	Connect it to a RJ45 cable.
GND	Used with external alarm device connection or hardware reset.
Alarm-in**	Used for external alarm device connection.
Alarm-out**	
RESET	Reserved for hardware reset. Remove the insulating coating of the wire, and twist it with the GND wire together to reset the camera to its factory values.
Line-in**	Colored as blue, used to connect to a microphone for audio input.
Line-out**	Colored as green, used to connect to a speaker for audio output.

* For PoE (IEEE802.3af) installation, make sure your network cable has the maximum cable resistance of 20Ω, such as CAT.5e or CAT.6 cables, to conform to the standard of IEEE802.3af.

** Optional

■ INSERT A MICRO SD CARD

The data originally saved in the micro SD card (if any) will be removed after inserting it to the camera. The camera doesn't support hot-swapping. Please insert or remove the microSD card with power disconnected.

■ FOR TYPE 1 AND 3 SELECTED MODELS ONLY

- Step1: With the front cover removed, find the microSD card slot in the camera.
- Step2: Follow the direction in the figure below to insert the MicroSD card properly:

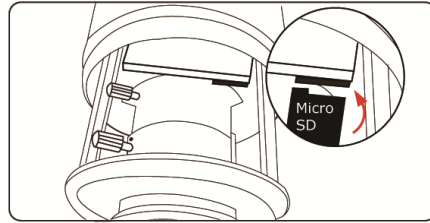

Note: It's recommended to use a pair of tweezers for inserting / removing MicroSD card.

- Step 3: Screw back the front cover.

Note: Please do put the rubber gasket back on the right position in case of water penetration.

■ FOR TYPE 4 SELECTED MODELS ONLY

- Step1: Remove the four screws and open the front cover.

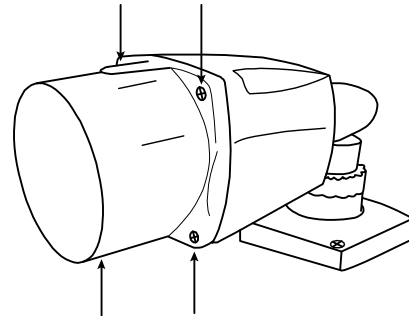

- Step 2: Gently open the front cover and locate the Micro SD card slot.

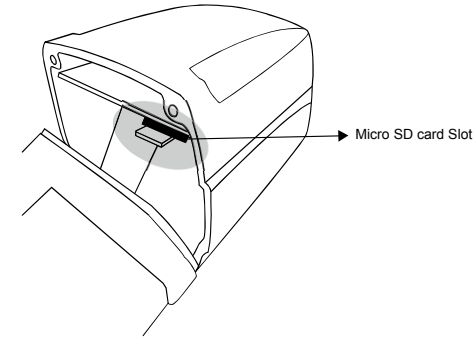

- Step 3: With the front cover removed, find the Micro SD card slot in the camera. Insert the Micro SD card as shown in the picture below

- Step 4: Screw back the front cover.

Note: Please do put the rubber gasket back on the right position in case of water penetration.

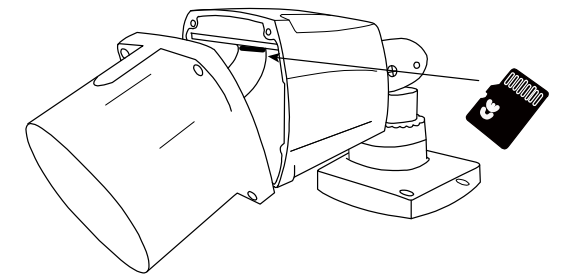

■ SYSTEM CONNECTION

1. Connect IP cameras and a monitor to the NVR, and power on the NVR, as illustrated below.

Note: Local connection only allows monitoring locally. To monitor from anywhere other than the NVR is installed, please connect your NVR to Internet.

2. Wait till each camera is configured automatically and you will see camera images on the monitor soon.

Note: Local connection only allows monitoring locally. To monitor from anywhere other than the NVR is installed, please connect your NVR to Internet.

Type1

Connect IP cameras
(as many as the NVR supports):

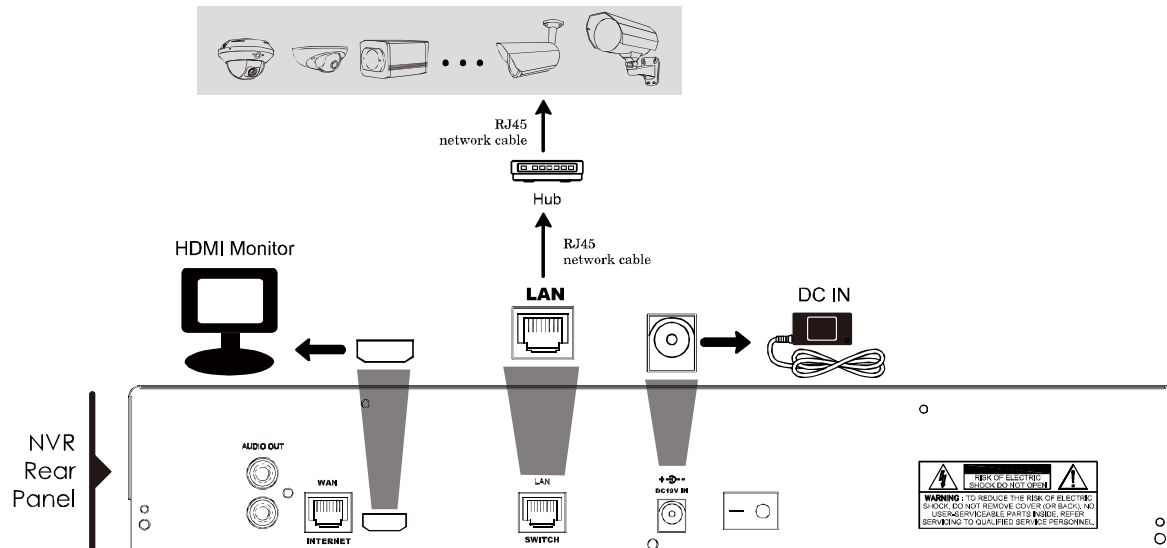

Type2

Connect IP cameras
(as many as the NVR supports):

